

Product Data Sheet

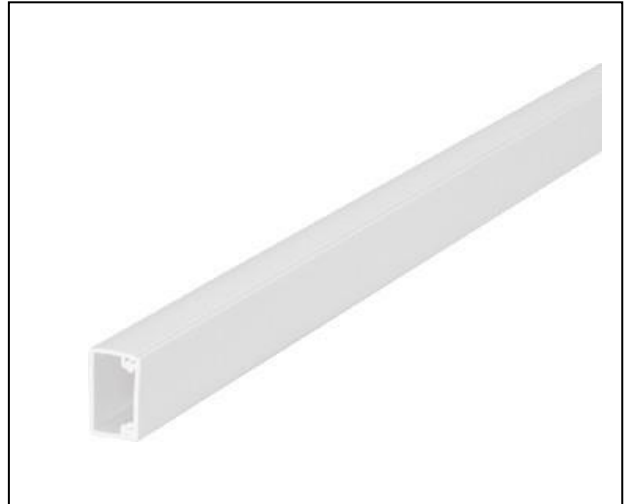

Product Code	Issue Number	Issue Date	Issue Reference
	1	04/07/21	MET008

Product Description
uPVC MINI TRUNKING



Features

Full range of accessories to compliment including angles, couplers, tees, moulded & painted colour finishes and more.

Moulded or fabricated accessory options.

Firm locking action defies accidental removal.

Compliance	BS 476 Part 7, BS 4678 Part 4
Material	uPVC – Flame Retardant
Finish	White (Standard)
Supplied Length	2.9 Metres
Size	200 x 50 mm

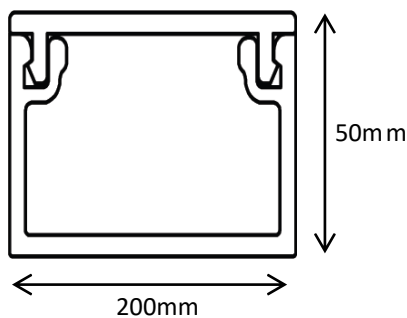

Environmental Information	<p>Packaging Waste: Outer Bag – 0.0034Kg /LDPE RoHS Compliant ref: 2011/65/EU</p> <p>uPVC Products are insoluble in water and will not degrade when buried in landfills etc.</p> <p>The products manufactured and otherwise supplied by the company do not have any perceived or known hazardous materials or by-products that would be deemed hazardous to the environment.</p>
Hazards Identification	No specific hazards as the ingredients are bound into the uPVC matrix and are thus rendered virtually insoluble.
Softening Point	(Extrusions) 82°C BS 2782 Method 120B.

Any trunking with a space factor equal to or larger than that of the cable factors will satisfactorily accommodate the desired cables

Thermal Properties

Metsec uPVC trunking systems are designed to accommodate local thermal expansion and contraction. The coefficient of linear expansion: $7.0 \times 10^{-5} \text{ } ^\circ\text{C}$ to 60°C .

All of the above information, including drawings, illustrations and graphic designs, reflects our present understanding and is to the best of our knowledge and belief correct reliable. Users, however, should independently evaluate the suitability of each product for the desired application. Under no circumstances does this constitute an assurance any particular quality or performance. Such an assurance is only provided in the context of our product specifications or explicit contractual arrangements. Our liability for products set forth our standard terms and conditions of sale

