

Technical Parameters

Parameters	8GB30 Distribution Board
Standard	IEC 61439-3
IP Protection	IP30/IP43
IK Protection	Ik09
Colour	RAL 9016 fine Texture
Gascket for IP43 protection	√
Reversible doors	√
Door Earthing	√
Knob type	Magnet Lock / Sliding Lock
Door Type	Frame Covering
Suitable for the Flush and Surface mounting	√
Box Insertion marks (Level Marks)	√
Detachable Gland Plate	Rectangular Cut Out
Side lock for Din Rail Channel	√
Insulated Neutral Bar	On top
Earth bar	√
Insulated bus-bar	Tin plated 100A Copper bus-bar
Masking Sheet	√
Certifications	RoHS

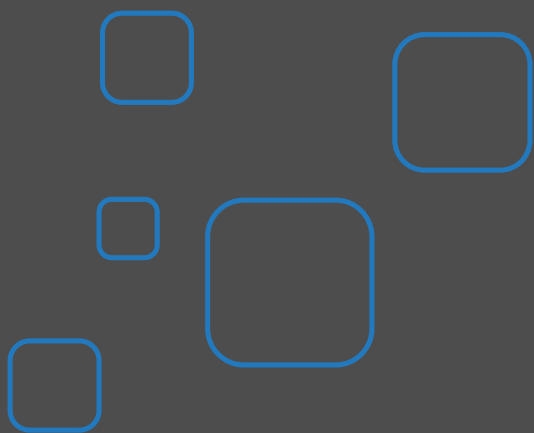

GA Drawing SS 1135 | SPN DB

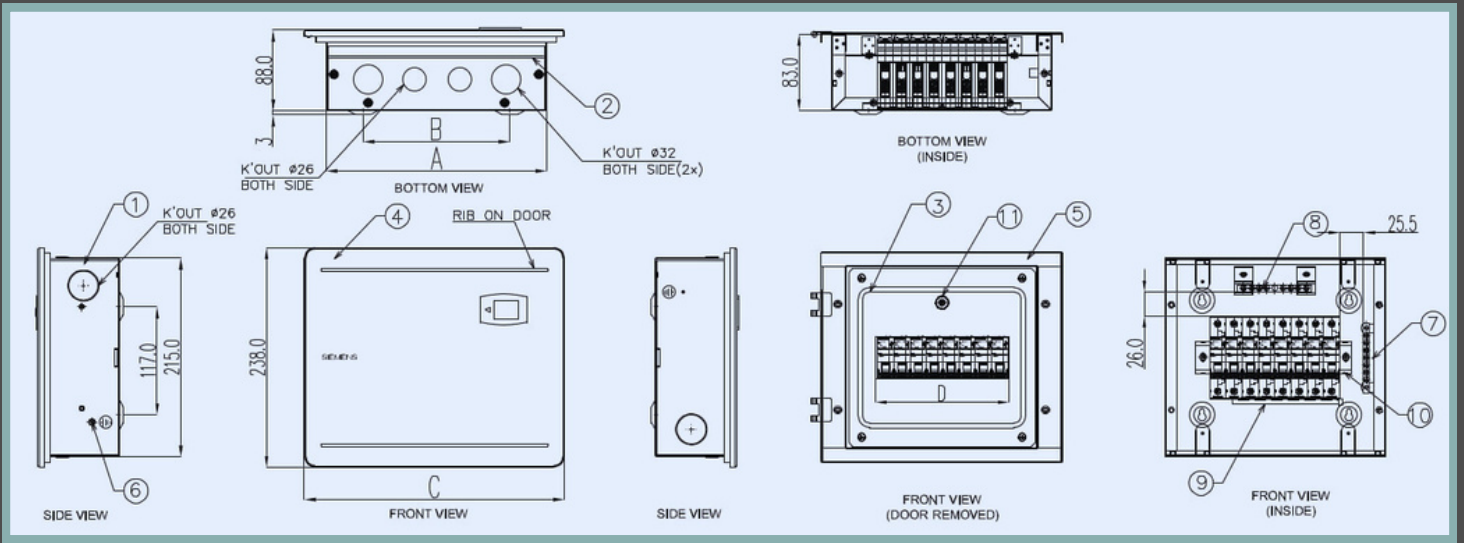

WAY	MLFB	MATERIAL NO	A	B	C	D	K'OUT (TOP/BTM)	NEUTRAL LINK	EARTH LINK	COPPER BUSBAR
04 WAY			166	86	209	72	2 0	4 Way-1Nos.	4 Way-1Nos.	3Way-(1x)
06 WAY			202	122	245	108	2 2	6 Way-1Nos.	6 Way-1Nos.	5Way-(1x)
09 WAY			238	158	281	162	2 2	6 Way-1Nos.	6 Way-1Nos.	8Way-(1x)
12 WAY			310	230	353	216	2 3	10 Way-1Nos.	10 Way-1Nos.	11Way-(1x)
15 WAY			382	302	425	270	2 5	14 Way-1Nos.	06 Way-2Nos.	14Way-(1x)

GA Drawing SS 1136 | TPN DB

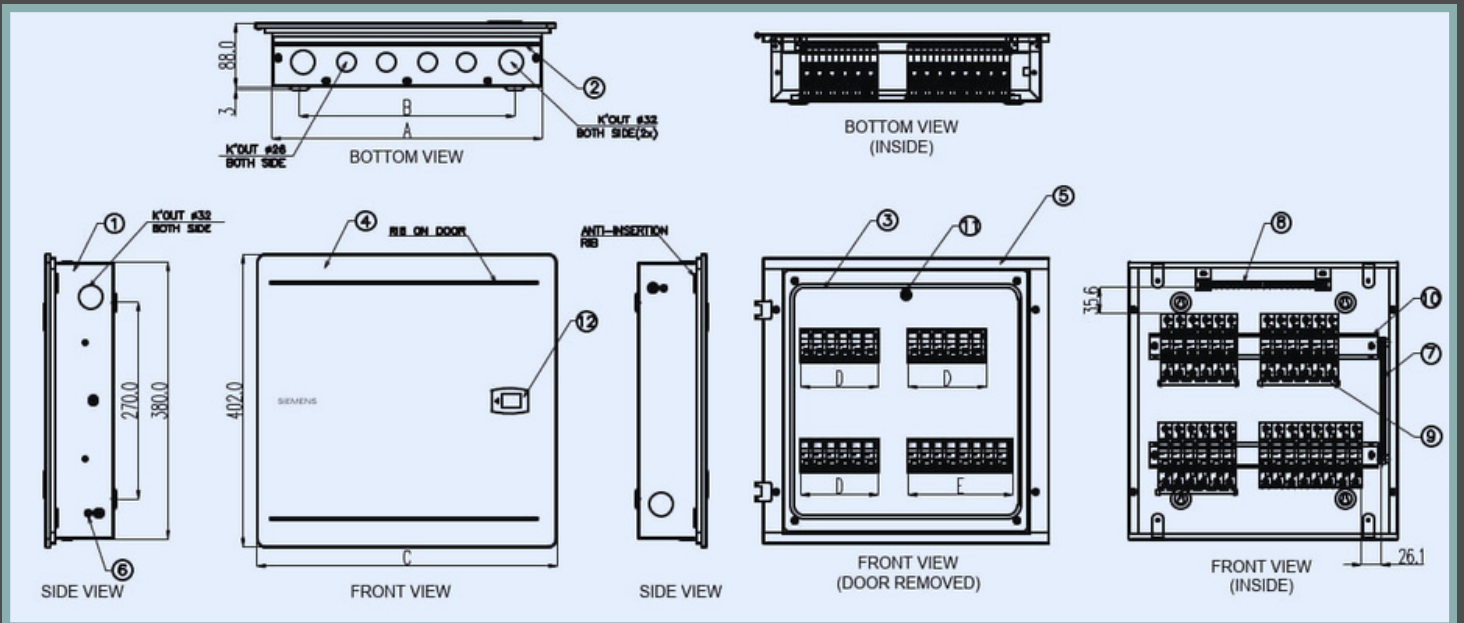

WAY	MLFB	MATERIAL NO	A	B	C	D	E	K'OUT (TOP/BTM)	NEUTRAL LINK	EARTH LINK	COPPER BUSBAR
4Way			335	190	377	72	144	2 3	12 Way-1Nos.	12 Way-1Nos.	4Way-(3x)
6Way			371	226	413	108	144	2 4	18 Way-1Nos.	18 Way-1Nos.	6Way-(3x)
8Way			437	262	479	144	144	2 5	12 Way-2Nos.	12 Way-2Nos.	8Way-(3x)
12Way			551	406	593	216	144	2 6	18 Way-2Nos.	18 Way-2Nos.	12Way-(3)
16Way			695	550	737	288	144	2 6	18 Way-2Nos.	14 Way-3Nos.	16Way-(3)

GA Drawing SS 1137 | VTPN DB

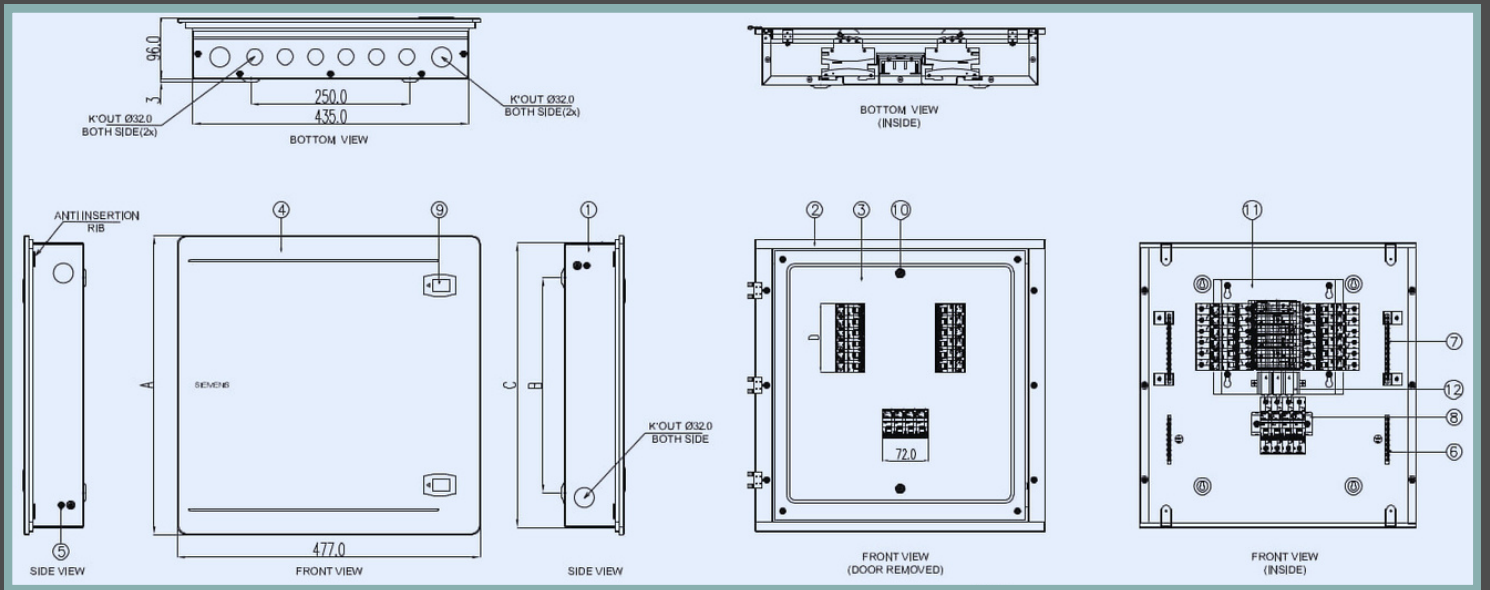

A	B	C	D	K'OUT		NEUTRAL LINK	EARTH LINK
				Ø32	Ø26		
470	338	448	108	2	6	06WAY-2x	06WAY-2x
524	392	502	162	2	6	10WAY-2x	10WAY-2x
578	446	556	216	2	6	12WAY-2x	12WAY-2x
686	554	664	324	2	6	18WAY-2x	18WAY-2x
794	662	772	432	2	6	12WAY-2x	22WAY-2x

